

壹 装备清点

1. 主机部份-----	1
2. 彩金显示器(广播盒)部份-----	2
3. 分机部份-----	3

貳 安装

1. 主机部份-----	4
2. 彩金显示器(广播盒)部份-----	5
3. 分机部份-----	6
4. 整套安装-----	7

參 调整

1. 彩金显示器(广播盒)部份-----	8
2. 分机部份-----	9

肆 操作

1. 扑克机台游戏者按键排列-----	10
2. 扑克机台配线-----	11
3. 主机操作流程简表-----	12
4. 主机操作说明-----	13
5. 错误讯息指示-----	16
6. 测试画面-----	17
7. 查帐及系统设定-----	18
8. 密码设定-----	20

附录 1. 2组连线使用1部印表机之安装-----	21
附录 2. 安装注意事项-----	21
附录 3. 连线标准配备一览表-----	22
附录 4. 当期报表-----	22
附录 5. 系统设定的各项目调整范围图表-----	23

// 特别注意事项：系统清除（归零）後，刚开始机率会比较高（甚至输钱）
所以除非必要，千万不要常去做系统清除或单机归零。

PART 1 装备清点

1. 主机部份



连线主机 X 1 PC

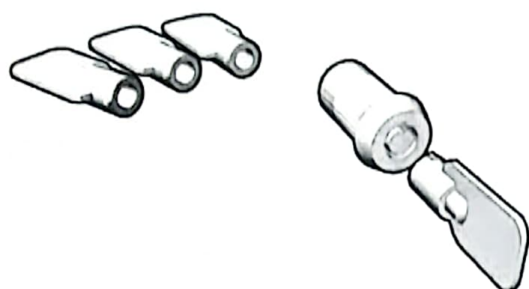

钥匙 X 4 把 (2个号码)



C01主机转接线 X 1 (20CM)
(每20部+1PC)

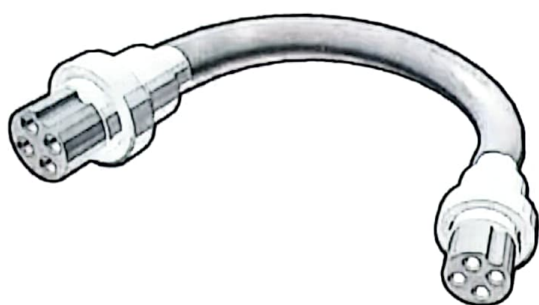

C03信号线 X 1 (15M)

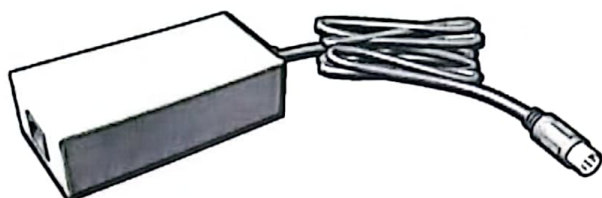

PW01连线主机电源 X 1

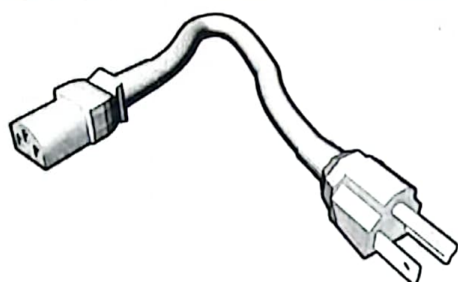

CAC01电源线 X 1

PART 1 装备清点

2.彩金显示器(广播盒)部份

彩金显示器



广播盒

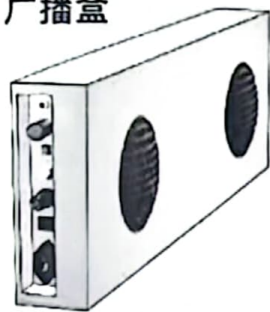

DSP01彩金显示器(广播盒)
X 1 PC

#有彩金机种使用彩金显示器
无彩金机种使用广播盒

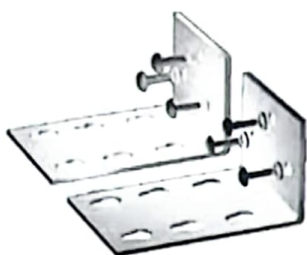

M03彩金显示器(广播盒)
固定铁片 X 1 SET
(L型铁片两组+8个螺丝及垫片)

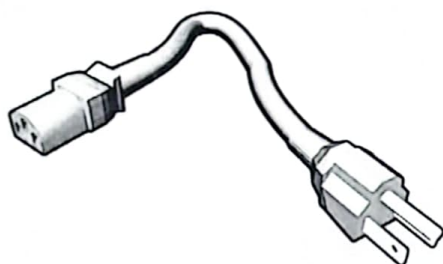

CAC01电源线 X 1

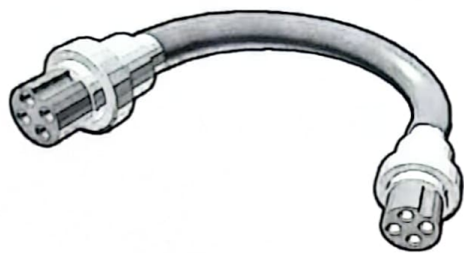

C03信号线 X 1 (15M)

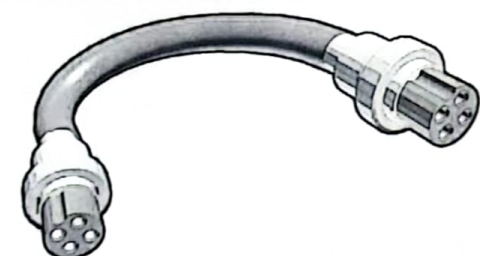

C02信号线 X 2 (1.5M)

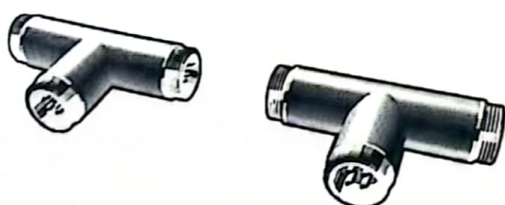

CNT01彩金显示器(广播盒)
分接头 X 3

PART 1 装备清点

3.分机部份(每片)

PC板 X 1 PC

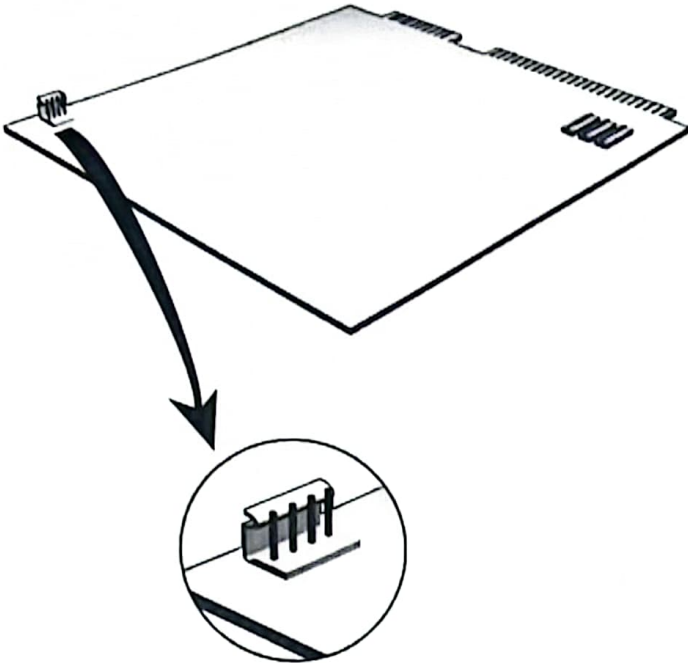

C04分机信号线 X 1(0.9M)
(每20部+1PC)



C02信号线 X 1 (1.5M)
(每10部+1PC)

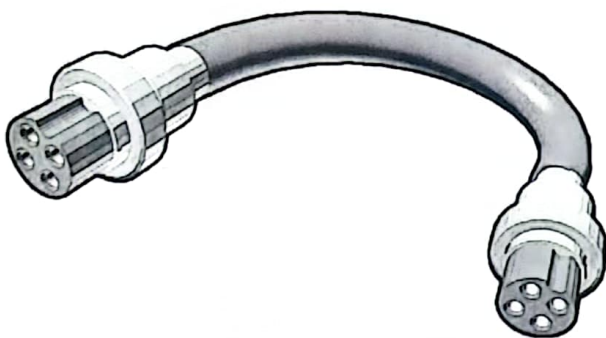

连线标准配备一览表<附录3>

PART 2 安装

1. 主机部份

(一) 电源

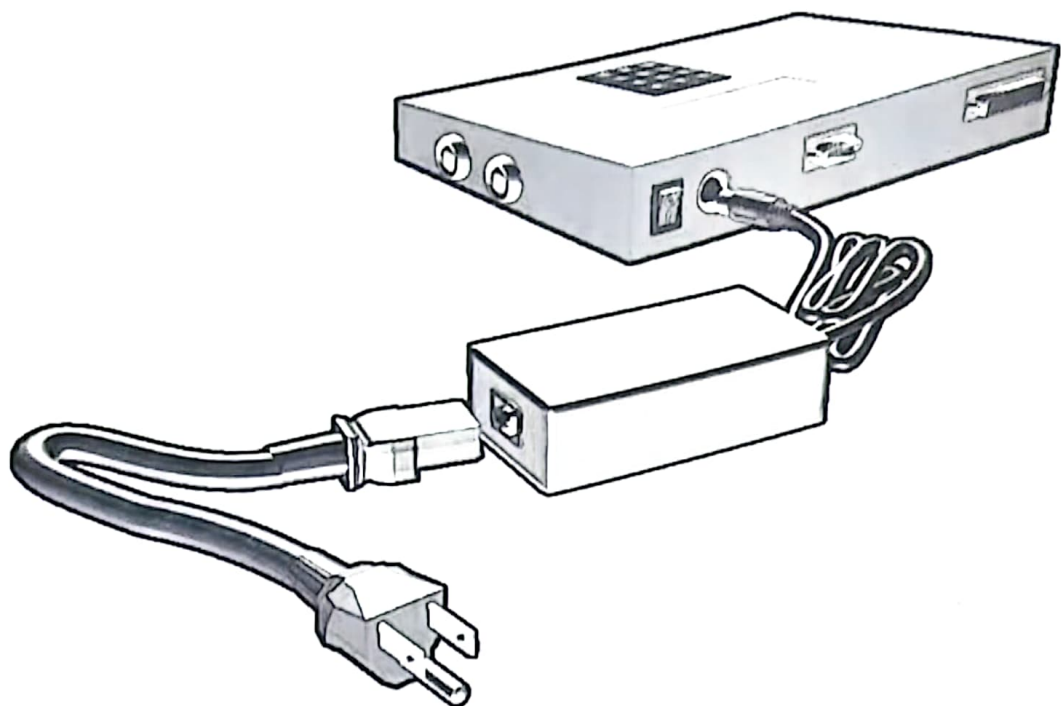

(二) 信号线

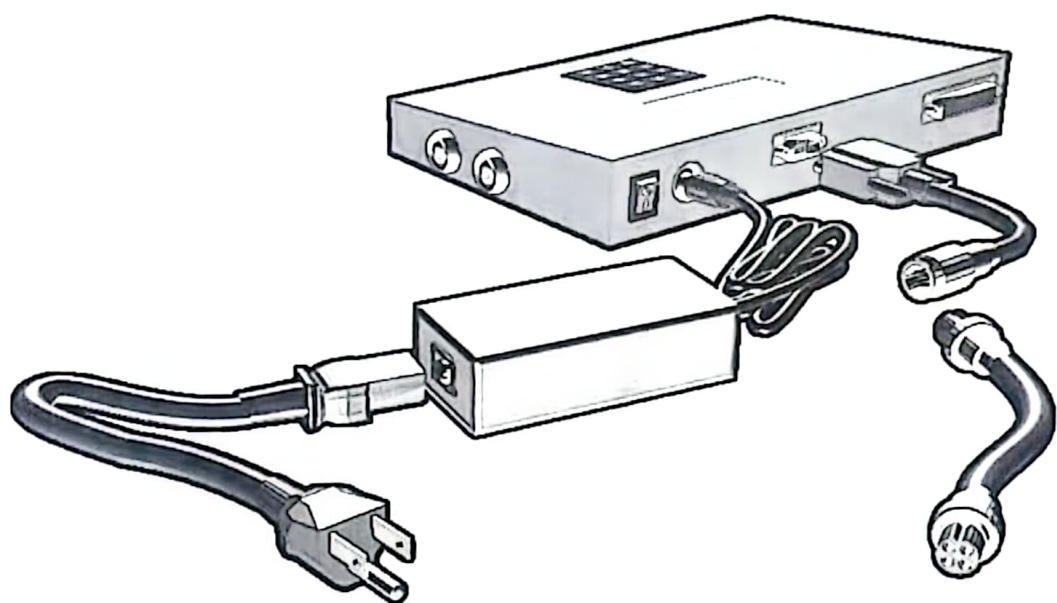

PART 2 安装

2.彩金显示器(广播盒)部份

(一)固定方式

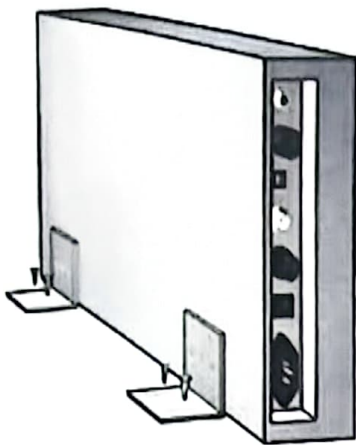

平面式

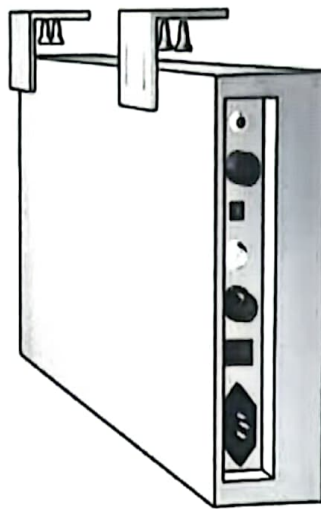
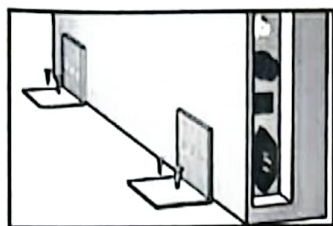

悬吊式

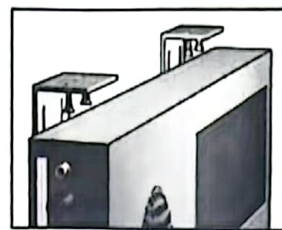

(二)电源安装

彩金显示器(广播盒)

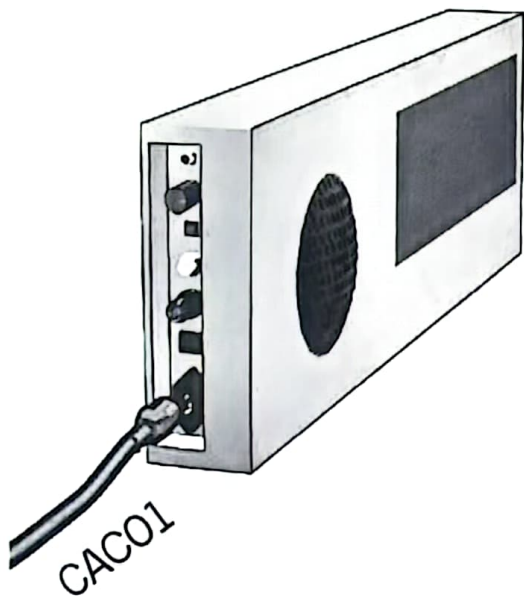

(三)信号线安装

彩金显示器(广播盒)

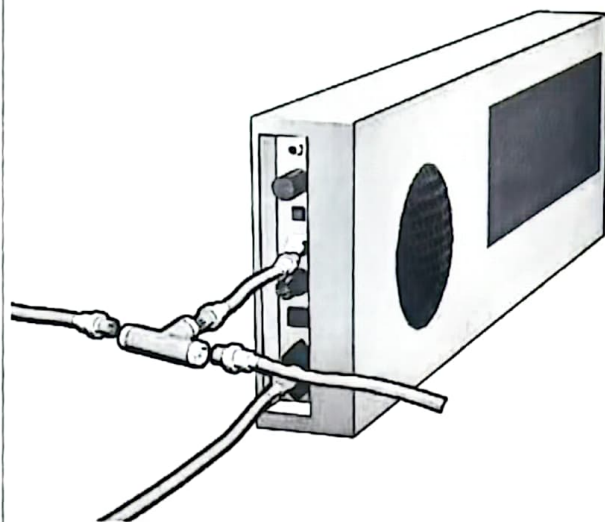

PART 2 安装

3. 分机部份

分机信号线

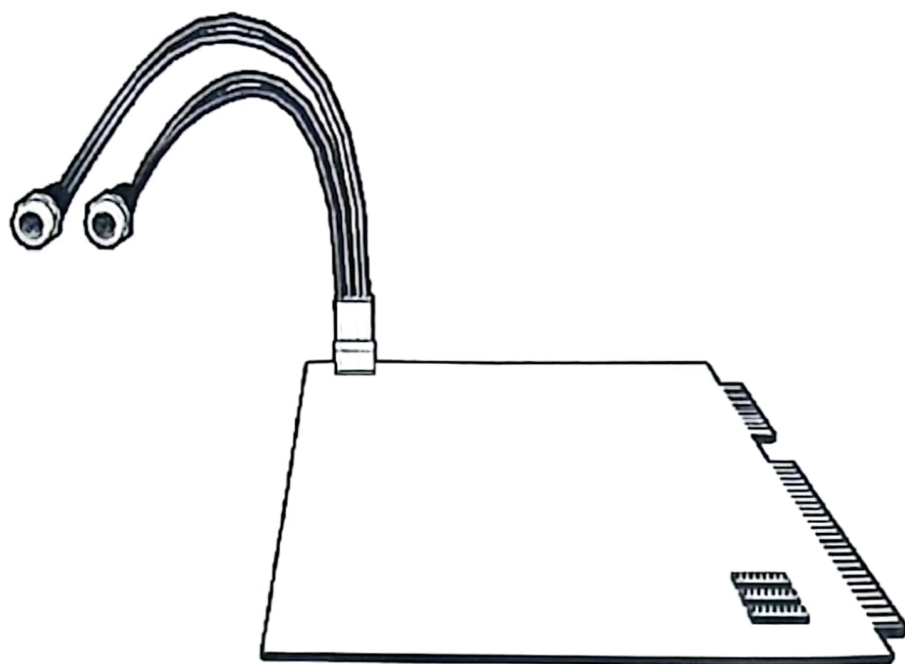

红 黑

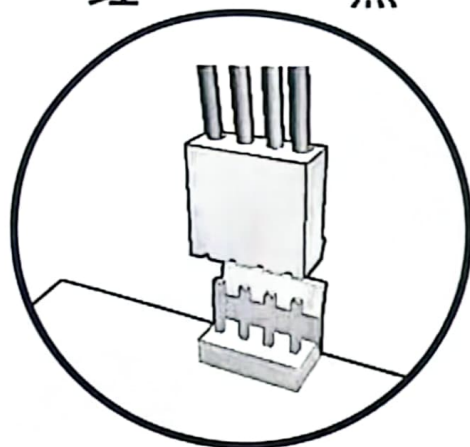

请注意方向

PART 2 安装

4. 整套安装

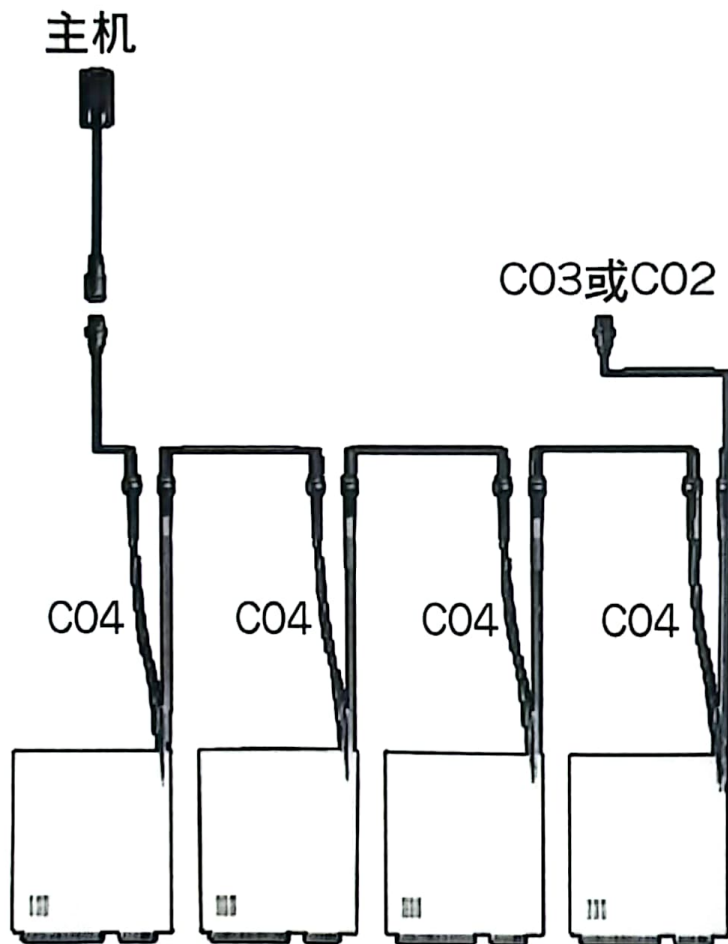
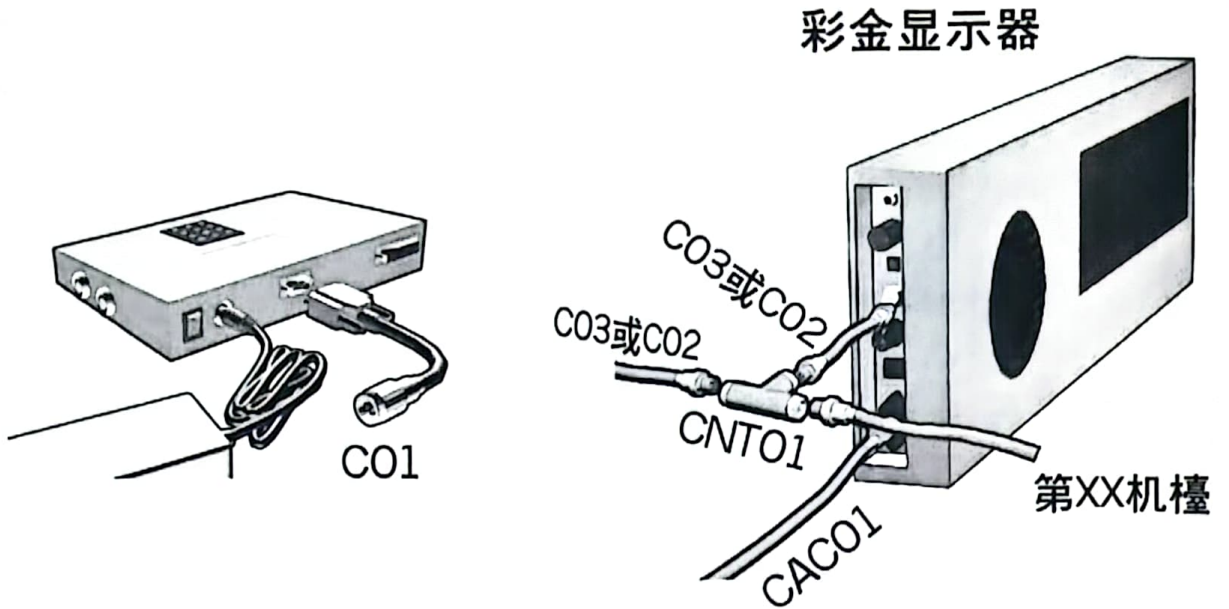

PART 2 安装

4. 整套安装

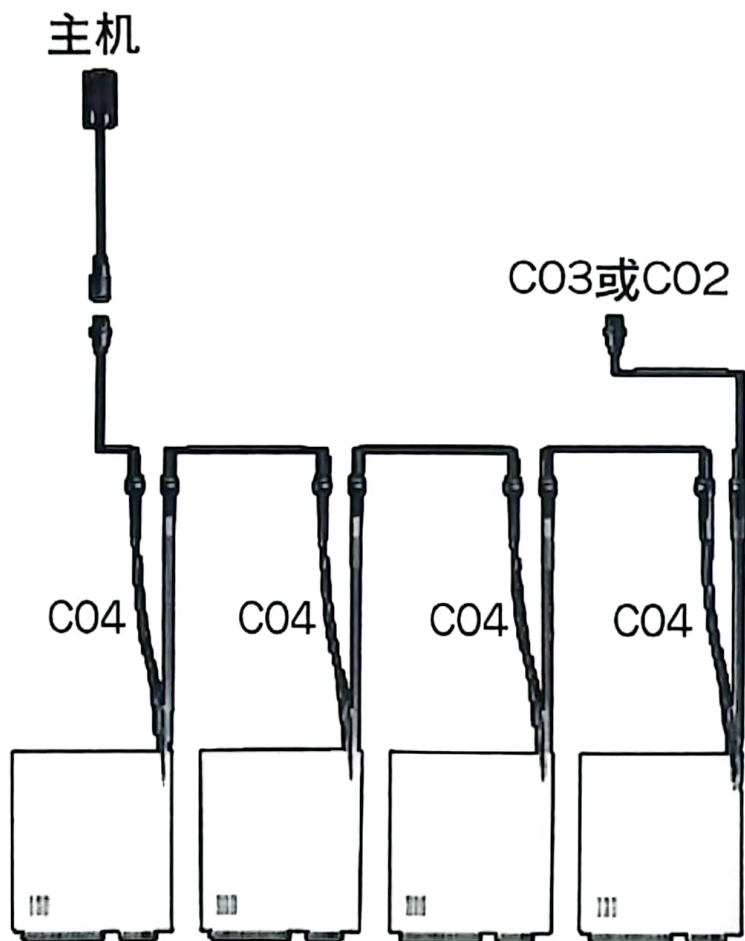
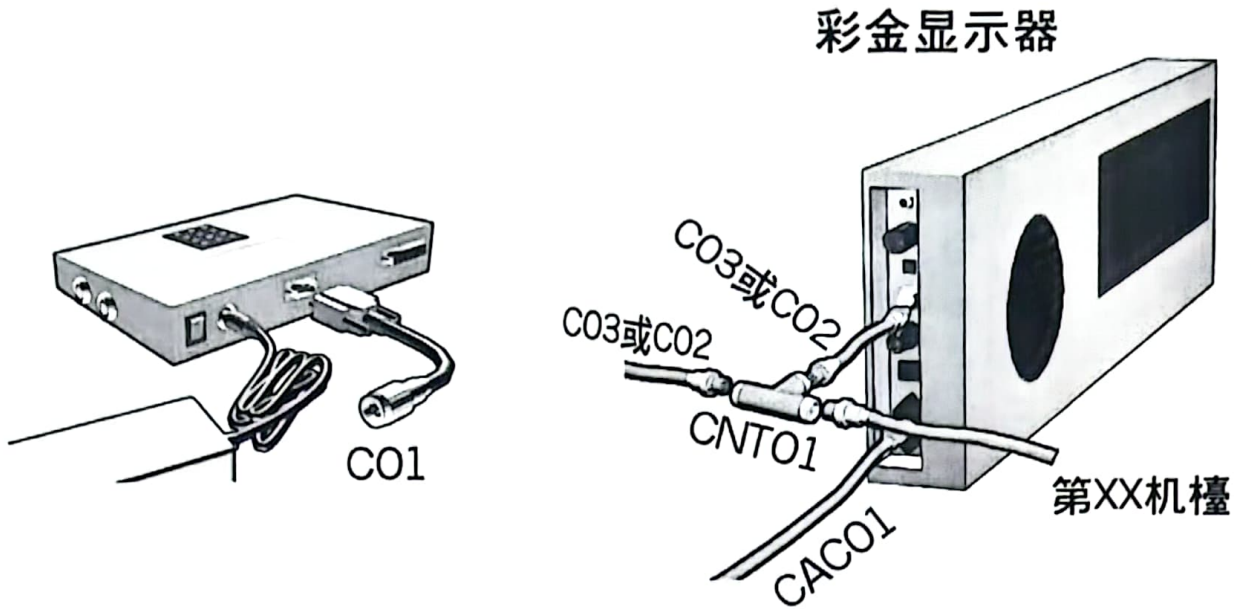

PART 3 调整

1. 彩金显示器(广播盒)部份

※彩金显示器

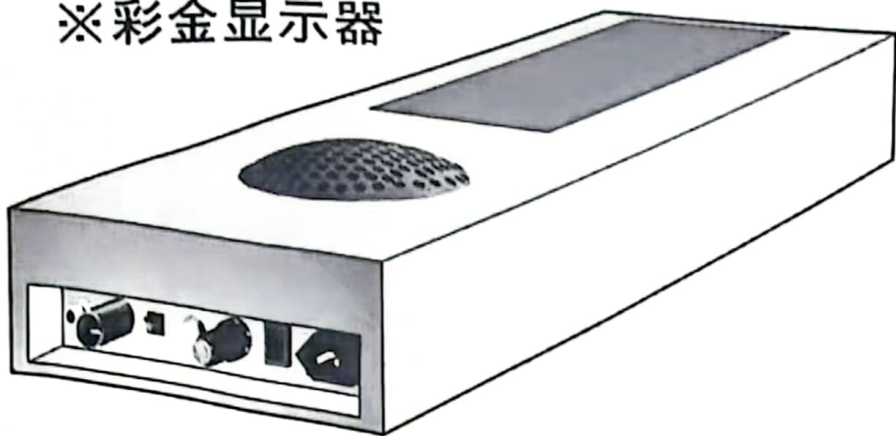

※广播盒

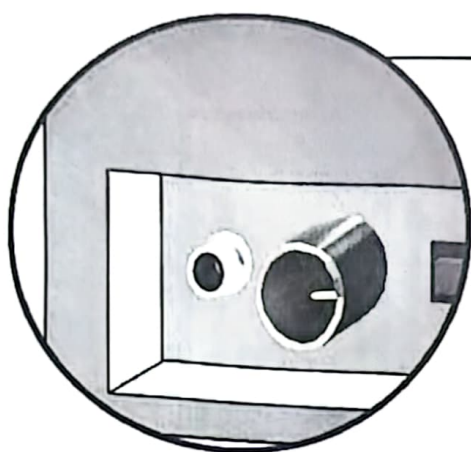
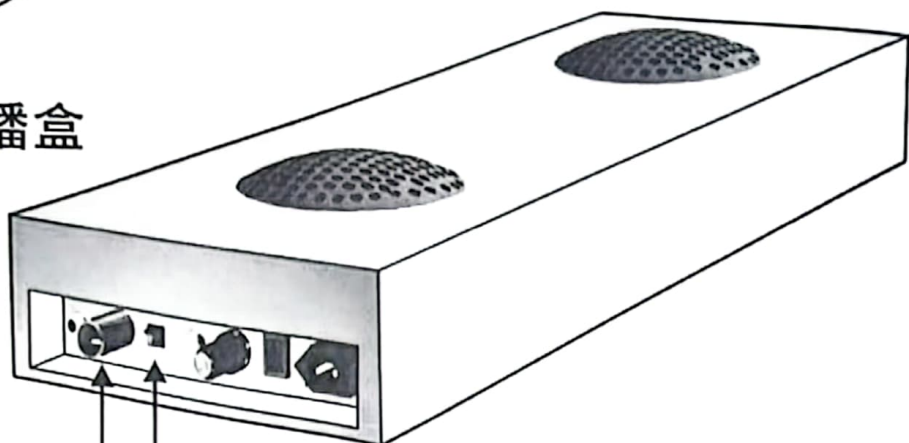

※音量调整

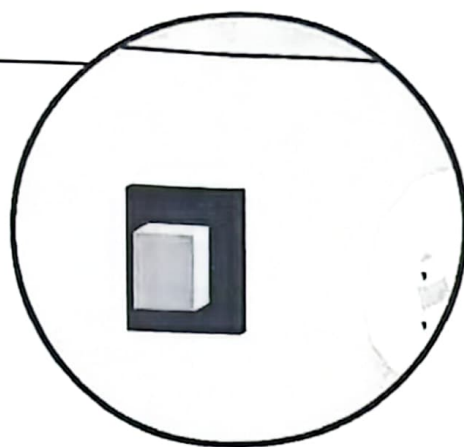

※硬体测试：按〈测试键〉再打开电源，即自动进入测试。

PART 3 调整

2.分机部份

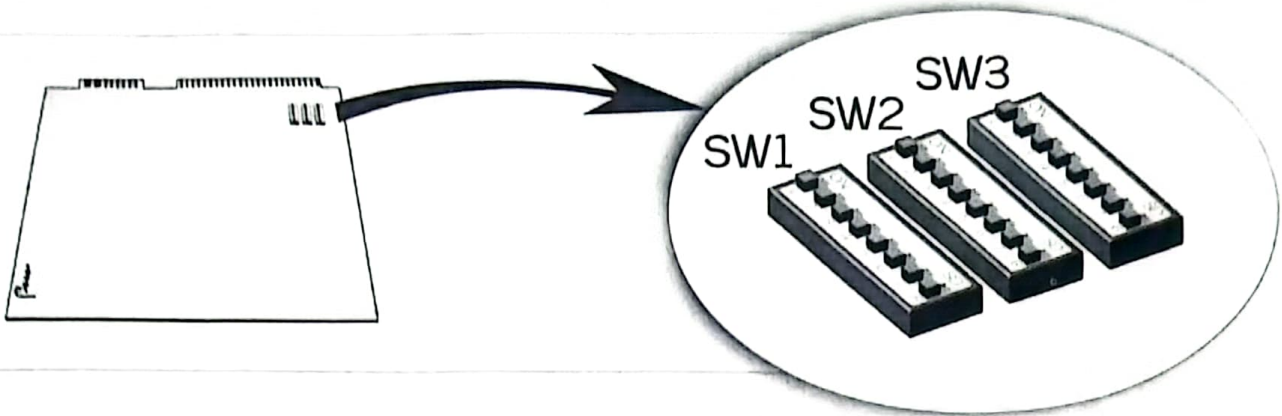

DIP SW1			1	2	3	4	5	6	7	8
副机号设定	第 1 檯		OFF	OFF	OFF	OFF	OFF			
	第 2 檯		ON	OFF	OFF	OFF	OFF			
	第 3 檯		OFF	ON	OFF	OFF	OFF			
	第 4 檯		ON	ON	OFF	OFF	OFF			
	第 5 檯		OFF	OFF	ON	OFF	OFF			
	第 6 檯		ON	OFF	ON	OFF	OFF			
	第 7 檯		OFF	ON	ON	OFF	OFF			
	第 8 檯		ON	ON	ON	OFF	OFF			
	第 9 檯		OFF	OFF	OFF	ON	OFF			
	第 10 檯		ON	OFF	OFF	ON	OFF			
	第 11 檯		OFF	ON	OFF	ON	OFF			
	第 12 檯		ON	ON	OFF	ON	OFF			
	第 13 檯		OFF	OFF	ON	ON	OFF			
	第 14 檯		ON	OFF	ON	ON	OFF			
	第 15 檯		OFF	ON	ON	ON	OFF			
	第 16 檯		ON	ON	ON	ON	OFF			
	第 17 檯		OFF	OFF	OFF	OFF	ON			
	第 18 檯		ON	OFF	OFF	OFF	ON			
	第 19 檯		OFF	ON	OFF	OFF	ON			
	第 20 檯		ON	ON	OFF	OFF	ON			

DIP SW2		1	2	3	4	5	6	7	8
示范音乐	有	OFF							
	无	ON							

副机檯号调整过後必须开关机，才算完成设定。

PART 4 操作

1. 扑克机台游戏者按键排列

猜大

续玩

猜小

押注



得分

保 1
(半续玩)

保 2

保 3

保 4
(双续玩)

保 5
(第六张)

开牌

PART 4 操作

2. 扑克机台配线

零件面	A	B	焊锡面
	1A	1B	
	2A	2B	
	3A	3B	
	4A	4B	
RC	5A	5B	RA
RD	6A	6B	RB
H.P.SW	7A	7B	
洗分键	8A	8B	押注键
小	9A	9B	查帐键
大	10A	10B	开牌键
得分键	11A	11B	扫描板-蓝色
续玩键	12A	12B	扫描板-同步
退币键	13A	13B	扫描板-绿色
投币键	14A	14B	扫描板-红色
保留4/双续玩	15A	15B	测试键
开分键	16A	16B	保留1/半续玩
保留3	17A	17B	保留2
保留5/第六张	18A	18B	
GND	19A	19B	声音
洗分计数器	20A	20B	开分计数器
退币计数器	21A	21B	投币计数器
SSR	22A	22B	SSR

	1	1	
	2	2	
	3	3	
	4	4	
+12V	5	5	+12V
	6	6	
+5V	7	7	+5V
+5V	8	8	+5V
GND	9	9	GND
GND	10	10	GND

PART 4 操作

3. 主机操作流程简表

查帐锁功能

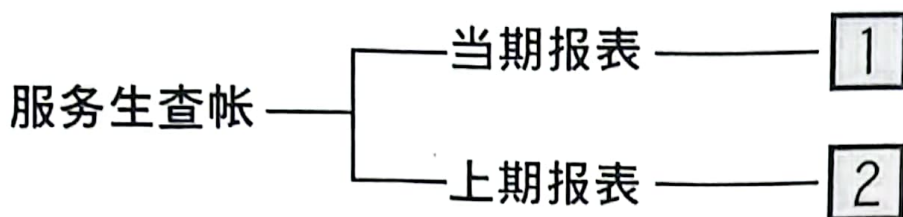

清除锁功能

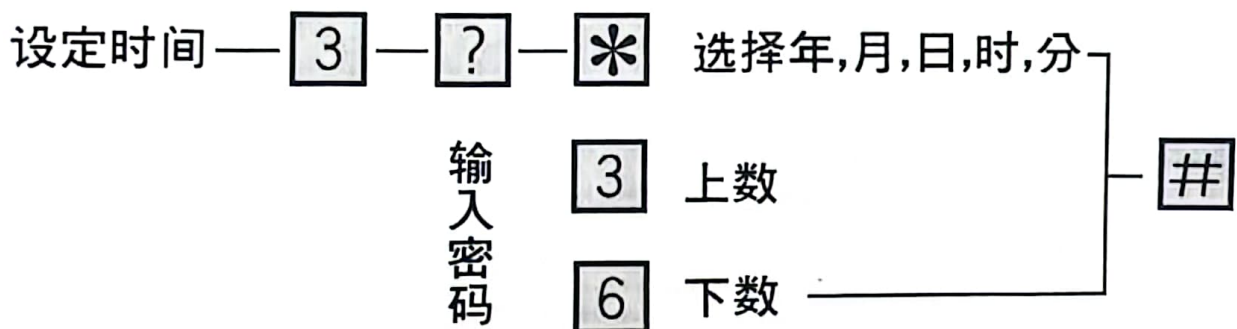
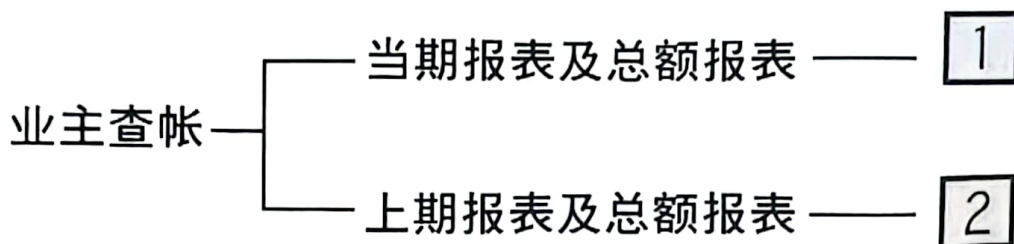
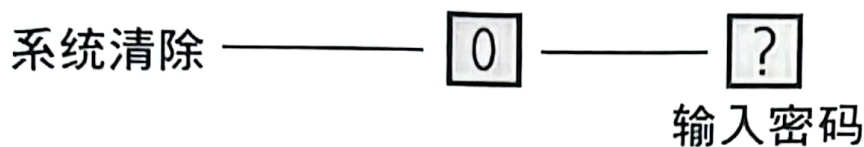

PART 4 操作

4. 主机操作说明

系统清除：

步骤：①

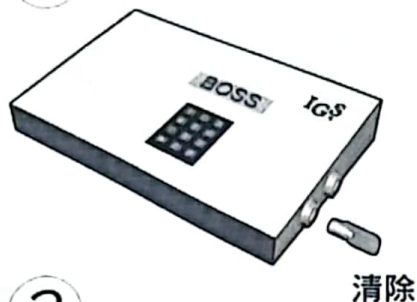

步骤：②

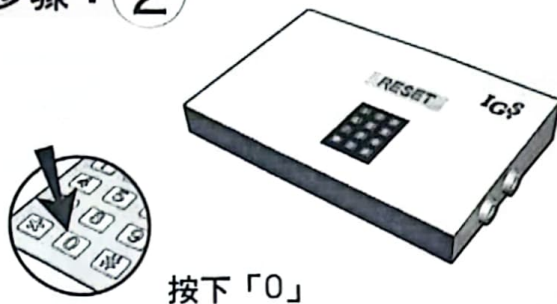

步骤：③

输入密码：

- [1] 输入密码"666666"。
- [2] 若密码正确会显示"RESET", 并自动清除。
- [3] 若密码错误会显示"PAS ER"。

更换密码：

- [1] 在 "BOSS" 中按"4", 输入"旧密码"。
- [2] 出现"NEW"後, 输入"新密码"。
- [3] 出现"CHECK"後, 再输入一次"新密码"。

使用时机：1. 第一次营业需执行系统清除。
2. 更换主机程式版本。

注意事项：清除帐目过程中应避免开关电源，并注意有那些机台没有连线，如果中途断电请重新操作一次。

查帐功能：

服务生查帐：服务生可以查当期报表及上期报表

步骤：①

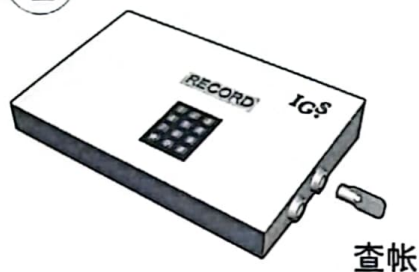

步骤：②



注意事项：查帐之前，应先打开印表机。当期报表见<附录4>

PART 4 操作

业主查帐：

业主可以查「当期及当期总额报表」「上期及上期总额报表」

步骤：①



步骤：②

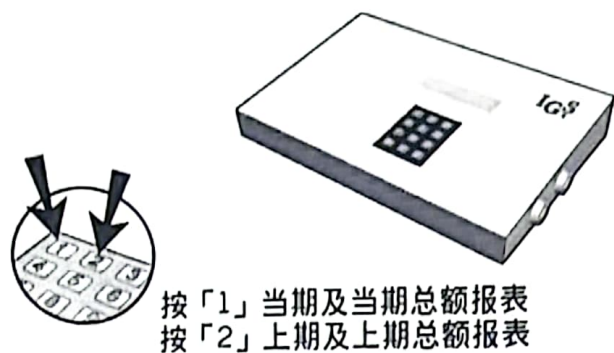

注意事项：查帐之前，应先打开印表机

查帐功能：

步骤：①

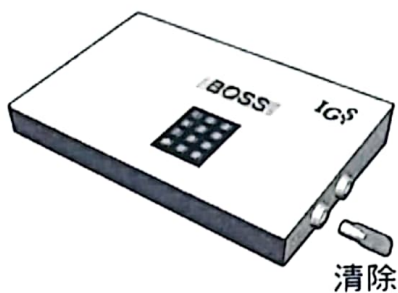

步骤：②

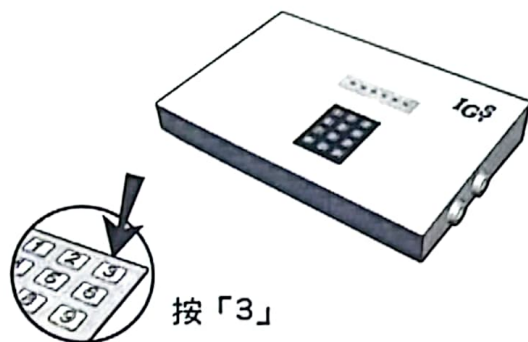

步骤：③ 输入密码「666666」主机会显示



PART 4 操作

步骤：④ 步骤4：按 **#** 可依次选择设定年月日时分

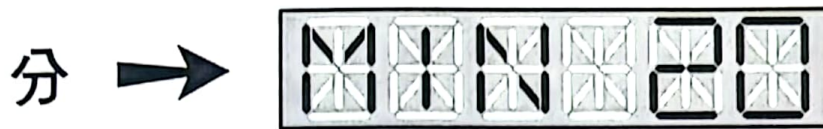

步骤：⑤

步骤：⑥



按「3」往上调整
按「6」往下调整



时间设定完成后按 **#**

PART 4 操作

5. 错误讯息指示

▶ 印表错误：

若主机显示



则表示印表错误

处理方式如下：

① 纸张？

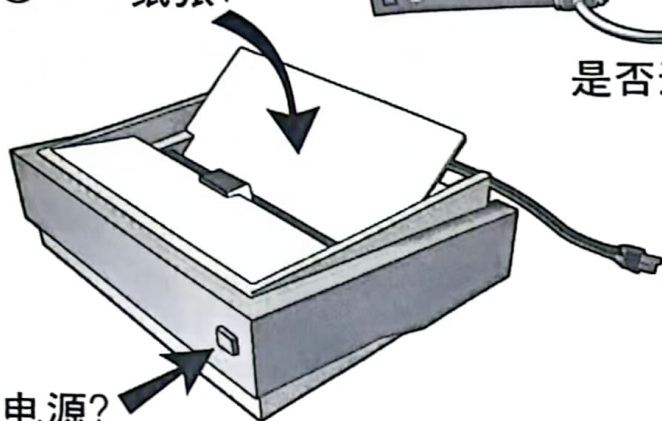

电源？

是否连线？

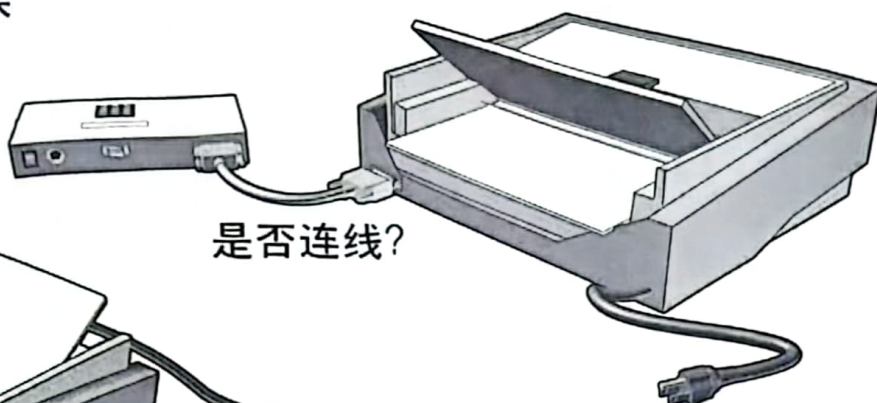

② 列印「当期帐」过程中如有印表错误，可按〈*键〉重新列印或按〈#键〉放弃列印。

③ 若选择〈#键〉放弃列印，若需要「当期帐」的报表时，可印「上期帐」，此时「上期帐」即为「当期帐」；列印其他报表错误时，可按〈#键〉放弃列印，排除故障后再重新列印。

▶ 通讯干扰： 闪烁



接收/传送

干扰类型

机台编号

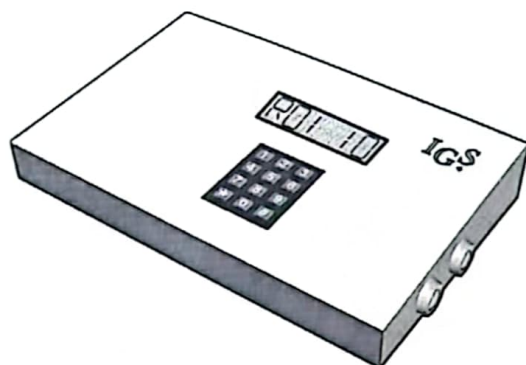

① 机台编号重覆，强力无线电波干扰，通讯短路，子机开关电源故障等问题。

② 瞬间干扰可不必理会（如开关电源等问题）。

PART 4 操作

6. 测试画面

按键及声音测试

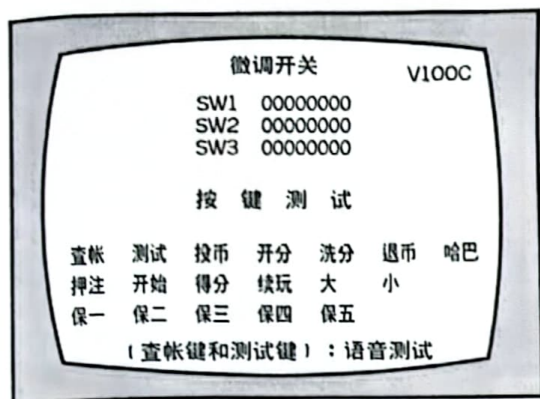

按住<测试键>再将电源打开即可测试按键和DIP SW好坏。

查帐键



测试键



同时按住



进行[语音测试]



PART 4 操作

7. 查帐及系统设定

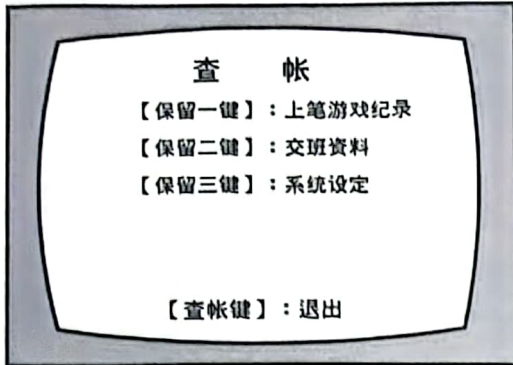

在DEMO或押注画面时，按住<查帐键>即可进行查帐及系统设定。

上笔游戏纪录

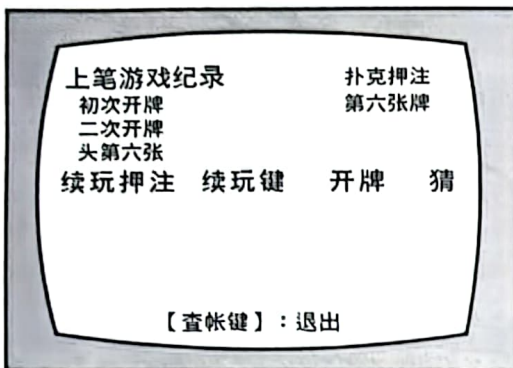

交班资料

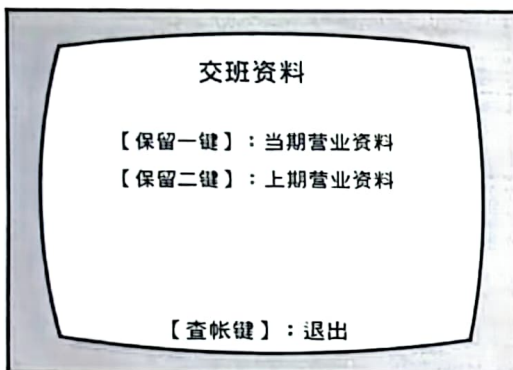

当期营业资料



上期营业资料



PART 4 操作

系统设定

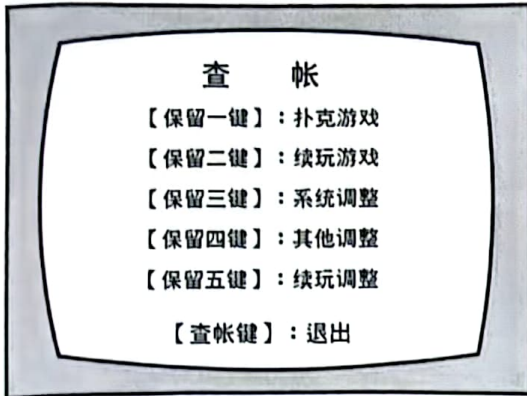

系统调整，必须输入密码，密码为八个开始键，才能进入系统设定。

系统调整

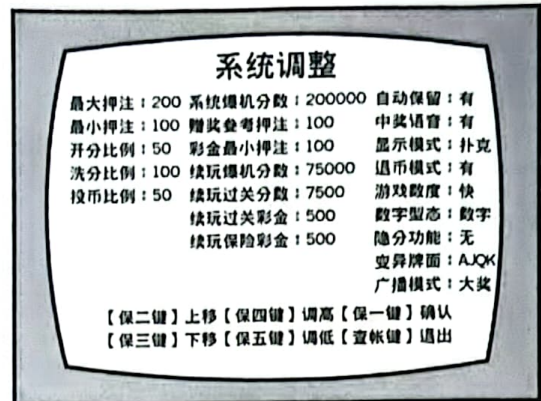

必需按<保一键>确定过後才算调整成功。

其他调整

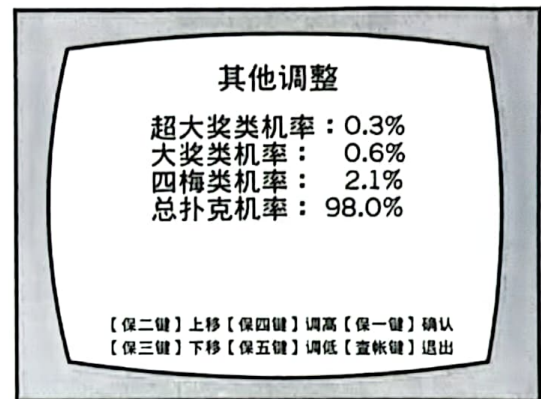

必需按<保一键>确定过後才算调整成功。

扑克游戏



续玩游戏

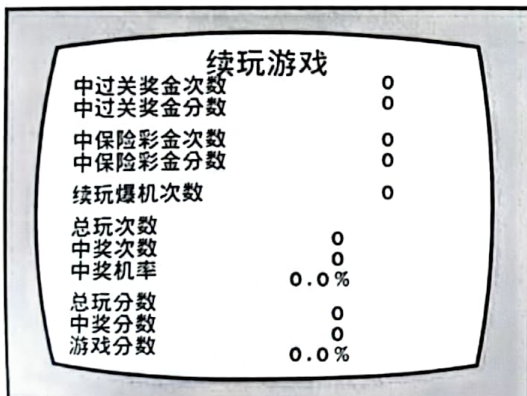

续玩调整



必需按<保一键>确定过後才算调整成功。